

Mag International Inc.

Owner's Manual  
T-MAG XC Mini Truck Series  
With 4WD Operating Instructions

## FORWARD

Congratulations on your selection of the T-MAG XC series of Off-Road Mini Utility Trucks.

This Owners Manual is a component of your vehicle and it provides useful information on operation, maintenance and safety applications. The manual is to be kept inside your vehicle for easy reference. Read it carefully and make sure you fully understand the contents of the manual, *especially the safety information*.

It is forbidden to willfully refit or add other equipment to your vehicle; especially to the braking system, steering or other mechanical parts related to the safety and the handling of the vehicle. Any direct or indirect loss caused by the above-mentioned refitting or modification with additional equipment will be assumed at the owners expense.

Our policy is to continually upgrade and improve our product, therefore; we reserve the right to make changes on specific structural features at any time without any given notice. However, a new and revised manual will become available in the event any major changes occur.

### IMPORTANT NOTES

- The engine type and “EX” work number are at the right side of the engine cylinder block
- The vehicle ID Badge is located in the center *under the hood*
- The CARB sticker is located under the driver seat
- The customers invoice number is referenced by means of a black ID sticker
- (Inside the driver door) this reference number can be used for the ordering of parts

## TABLE OF CONTENTS

### 1) SPECIFICATIONS

- 1.1 Performance
- 1.2 Mass Data
- 1.3 Dimensions
- 1.4 Engine Data
- 1.5 Name Plate
- 1.6 Engine Number
- 1.7 Vehicle Identification Number (VIN)

### 2) VEHICLE LAYOUTS

- 2.1 Outside
- 2.2 Instruments and Controls
- 2.3 Interior
- 2.4 Engine

## TABLE OF CONTENTS

### 3) OPERATIONS (Including 4WD Option)

- 3.1 Opening the Doors
- 3.2 Windows, Rear-View Mirror and Sun Visor
- 3.3 Seats and Headrests Regulation
- 3.4 Seat Belts
- 3.5 Switches
- 3.6 Indication Lights and Dome Lights
- 3.7 Instruments
- 3.8 Rear Window Defogger
- 3.9 Cigarette Lighter and Ashtray
- 3.10 Air Conditioner
- 3.11 Glove Box
- 3.12 Radio and Tape Player
- 3.13 Parking Brake Lever
- 3.14 4WD Operating Instructions

## TABLE OF CONTENTS

### 4) DRIVING

- 4.1 Exhaust Emissions and Restraining Devices
- 4.2 Inspecting Items Before Daily Use
- 4.3 Vehicle Driving Notice
- 4.4 Engine Starting
- 4.5 Operation of Transmission
- 4.6 Braking
- 4.7 Clutch, Brake and Accelerator
- 4.8 New Vehicle Driving
- 4.9 High Speed Driving
- 4.10 Driving on the Special Road
- 4.11 Cargo and Towing

### 5) EMERGENCY MANAGEMENT

- 5.1 Engine Overheat
- 5.2 Towing of Vehicle
- 5.3 Emergency Assistance

## TABLE OF CONTENTS

### 6) DO IT YOURSELF

- 6.1 Tools Included with Vehicles
- 6.2 Use of the Jack
- 6.3 Changing the Tire
- 6.4 Spark Plug
- 6.5 Fuses
- 6.6 Replacement of Light Bulbs

### 7) INSPECTION AND MAINTENANCE

- 7.1 Safety Notes About Inspection and Maintenance
- 7.2 Daily Check and Maintenance
- 7.3 Periodic Inspection and Maintenance Schedule
- 7.4 Simple Inspection and Maintenance Items

### 8) LUBRICATION AND ANTI-CORROSION

- 8.1 Maintenance of Interior
- 8.2 Maintenance of Exterior
- 8.3 Anti-Corrosion of Vehicle

## 1) SPECIFICATIONS

### 1.1 Performance

Item	Data
	T-MAG XC
Maximum speed (km/h)	
Maximum grade ability (%)	≥20
Fuel consumption of 100km at constant speed (L/100km)	≤5.5
Minimum turning diameter (m)	≤9.5
Minimum ground clearance (mm)	≥155
Wheel camber	1°30'±30'
Wheel kingpin inclination	9°30'±30'
Wheel caster	3°00'±30'
Wheel toe in (mm)	2 - 5
Approach angle/Departure angle	31°/30°
Main spring leaf/thickness	3(7,7,6)
Auxiliary spring leaf/thickness	1/13

### 1.2 Mass Data

Item	Data	
	T-MAG XC	
Curb mass (kg)	1050	1000
Maximum gross vehicle mass (kg)	1610	1560
Seating capacity (persons)	2	

### 1.3 Dimensions

Item	Data	
	T-MAG XC	
Overall length (mm)	3745 (3760#)	
Overall width (mm)	1505	
Overall height (mm)	1925	
Wheel base (mm)	2370	
Track (mm)	Front	1300
	Rear	1310
Front overhang (mm)	690	
Rear overhang (mm)	685 (700#)	

Note: Data with # indicates the dimension with skirt

#### 1.4 Engine Data

Item	Data	
Engine model	DA465Q	
Engine type	Four-in-line four-stroke water-cooled multi-point Electrically -controlled fuel injection	
Cylinder bore (mm)	65.5	
Stroke (mm)	72	
Total displacement (ml)	970	
Compression ratio	8.8	
Rated output (kW/r/min)	35.5/5000	
Maximum torque (Nm/r/min)	74/3000 ~ 3500	
Minimum fuel consumption (g/kWh)	275	
Fuel	Unleaded gasoline	

Item	Quantity	Item	Quantity
Engine oil	2.8 Liters	Transmission fluid	1.3 Liters
Coolant	4.5 Liters	Fuel tank	36 Liters

### **1.5 Name Plate**

The name plate is fixed on the bracket of wiper.

### **1.6 Engine Number**

The engine number is stamped on the engine cylinder of the inlet manifold side.

### **1.7 Vehicle Identification Number (VIN)**

The Vehicle Identification Number (VIN) is stamped on the upper surface of the right plate in the engine cabin.

## 2) VEHICLE LAYOUTS

### 2.1 Outside

- Hood
- Front windshield wiper
- Outside rear-view mirrors
- Side windows
- Antenna
- Front fog lights\*
- Headlights/Position lights
- Turn-signal lights
- Reversing lights
- Stop lights/Position lights
- Turn-signal lights (Hazard lights)
- Door lock
- License plate lights
- Rear fog lights
- Tires



\*Note: Equipment may vary with each vehicle

## 2.2 Instruments and Controls

1) Lighting switch/ Turn-signal switch	7) Mode selection dials	16) Hood release lever
2) Combination meter	8) Temperature control dials	17) Horn
3) Cluster instruments	9) N/A	18) Shift knob
4) Front windshield wiper and washer switch	10) Glove box	19) Cigarette lighter
5) Selection dial	11) Loud speaker cover	20) Parking brake lever
6) N/A	12) Side defogger	21) A/C switch
	13) Front fog light switch	22) Cap holder
	14) N/A	23) Ashtray
	15) Rear fog light switch	24) Radio player
		25) N/A

Note: The equipment may vary  
with each vehicle

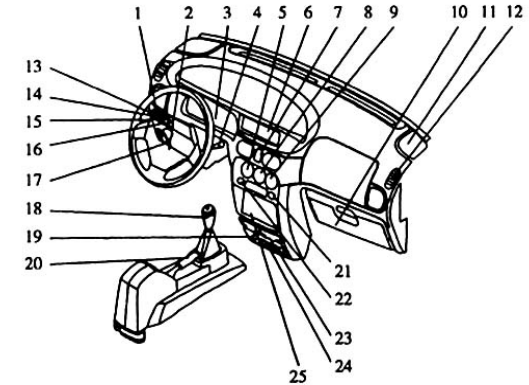

### 2.3 Interior

- 1) Inside rear-view mirror
- 2) Steering wheel
- 3) Sun visors
- 4) Driver's seat



### 2.4 Engine

- 1) Oil Filter
- 2) Engine
- 3) Ignition coil
- 4) Battery

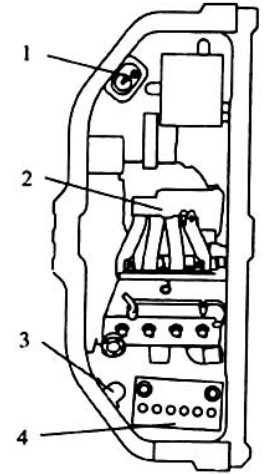

### 3) OPERATIONS

#### 3.1 Opening the Doors

##### 1. Key

Key provided is applicable to all doors, ignition switch and fuel filler cap locks.

##### 2. Door locks

###### a) Operation from outside the vehicle

There are two methods to lock the front doors; they are as follows:

- I. Close the door, insert the key and turn it toward rear of the vehicle.
- II. Press the inside door lock button down while pulling the outside handle up, close the door.

###### b) To unlock the front door, turn the key toward front of vehicle.

###### c) Operation from inside the vehicle

Press the inside door lock button down to lock the door, pull up the door lock button to unlock the door.

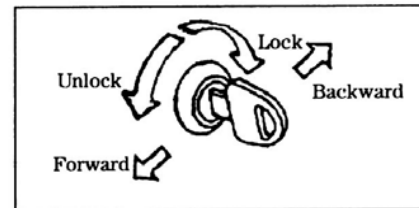

### 3. Fuel cap

The fuel cap is located on the on rear passenger side of the vehicle.

**WARNING!!!**

**NEVER ALLOW SPARKS OR OPEN FLAMES NEAR THE VEHICLE WHEN REFUELING.**

### 4. Hood latch

1) To open

- a) Put down the wiper if it is up.
- b) Pull up the control handle of the hood latch located on the lower left of the instrument panel. (The hood may bounce)
- c) Put your hand in the gap between the hood and the body; counter rotate the handle on the hood latch support to open. Support the hood by inserting the support bar in its slot.

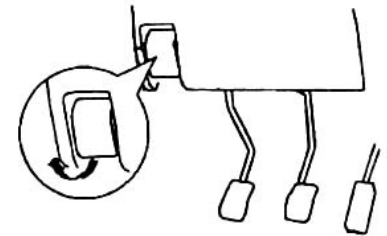

**WARNING!!!**

**ONLY OPEN THE HOOD WHEN THE WIPERS ARE IN THE DOWN POSITION.  
FAILURE TO DO SO MAY CAUSE PAINT DAMAGE.**

**WARNING!!!**

**THE SUPPORT BAR MAY DISENGAGE THE HOOD IF IT IS LIFTED BY A STRONG WIND.**

**(Always insert the support bar into the hole provided specifically for this purpose)**

**SUPPORTING THE HOOD AT ANY OTHER LOCATION COULD RESULT  
IN THE SUPPORT BAR SLIPPING OUT AND LEAD TO AN ACCIDENT.**

2) To Close

- a) Support the hood, release the support bar. Then secure the support bar to the clips located on the body.
- b) Slowly lower the hood to a position 300mm above the closed position, and then let it drop.
- c) Confirm that the hood is completely locked.

**WARNING!!!**

**KEEP HANDS AND OBJECTS AWAY WHILE CLOSING THE HOOD.  
BEFORE DRIVING, MAKE SURE THAT THE HOOD IS SECURELY LOCKED.  
PRESS FIRMLY DOWN ON THE HOOD TO CLOSE.**

### 3.2 Windows, Rearview Mirror and Sun Visor

#### 1. Window options

##### a) Manual windows

Turn the window crank clockwise to roll window down; turn counter-clockwise to roll window up.

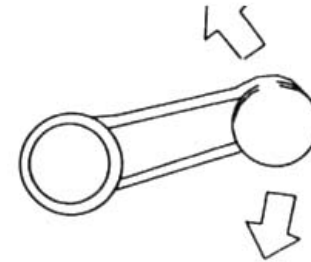

#### 2. Rearview mirror

##### a) Outside rearview mirror

The outside rearview mirror can be turned upward, downward, left and right to adjust to a suitable position.

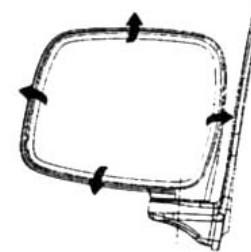

b) Inside rearview mirror

The inside mirror is located in the front upper to the driver's seat. It can be turned upward, downward, left and right to a suitable position. Please adjust the knob under the mirror to prevent the light of the rear vehicle from blinding the driver eyes while driving at night.



3. Sun visor

a) To be used to shelter sunlight not only from front, but also from the side, when moved away from the hook.

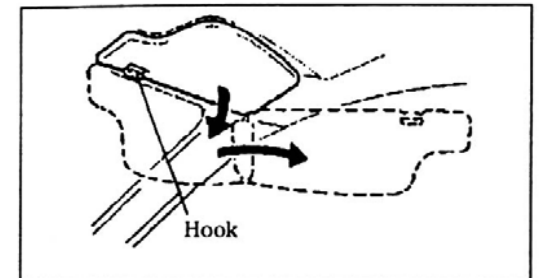

b) The clip to hold the visor is located on the reverse side of the sun visor on driver's side.

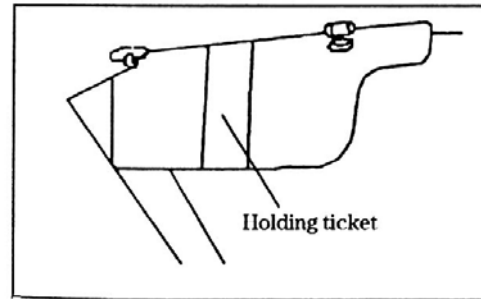

c) A mirror dressing is located at the back of the sun visor on the passenger side.

### 3.3 Seats and Headrests Regulation

#### 1. Front seat adjustment

- Seat should be adjusted prior to operation of vehicle.
- Elbows should be slightly bent at steering wheel.
- Knees should be slightly bent while applying brakes or accelerator.
- Proper use of seat belt should be adhered to at all times.
- Neck should be positioned at headrest level.

#### WARNING!!!

DUE TO OPERATION INFLUENCING DRIVING, SEAT ADJUSTMENTS MUST BE CARRIED OUT BEFORE OPERATING THE VEHICLE.

ACCIDENTS MAY OCCUR IF SEAT IS ADJUSTED WHILE OPERATING THE VEHICLE. ALWAYS ENSURE THE SEAT IS FIRMLY SET TO AVOID A POTENTIAL ACCIDENT. SERIOUS INJURY MAY BE CAUSED IF THE SEATBACK IS RECLINED DURING OPERATION OF VEHICLE.

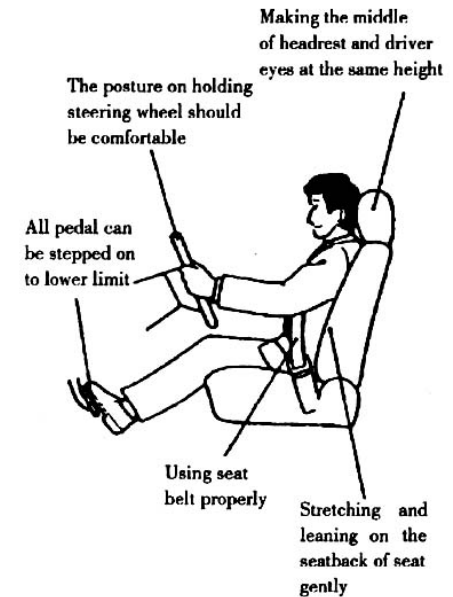

- a) Adjusting seat forward and backward  
Lift the lever to regulate the seat. After regulating make sure that the seat is fixed firmly by shaking the seat gently in moving direction.



- b) Adjust the angle of seatback  
Lift the handle to regulate angle of seatback. After regulating, make sure that the seat is fixed firmly by shaking the seatback gently.

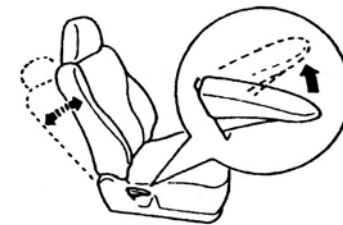

**WARNING!!!**

**LIFT LEVER AND PUSH THE SEATBACK TO APPROPRIATE ANGLE BY GUIDING SEAT WITH HAND;  
ASSURING THE SEATBACK WILL NOT RESULT IN INJURY TO PASSENGER AS IT RETURNS TO THE  
ORIGINAL POSITION.**

c) Adjustment of headrest

Adjust the middle of headrest assuring it is level with driver eyes. To adjust to this position, simply pull headrest upward. To lower, simply push headrest down to fixed position. While pressing the fixing button continuously, draw the headrest upward and remove it. To install the headrest, press the fixing button continuously and insert the headrest into the hole on the seatback.

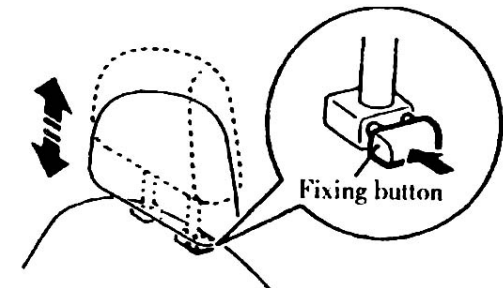

**WARNING!!!**

**THE MIDDLE OF THE HEADREST MUST BE ADJUSTED TO THE HEIGHT AT DRIVER'S EYE LEVEL. TO ENSURE DRIVER'S SAFETY, DO NOT EXCEED THE HEIGHT AND DO NOT ADD CUSHION ETC. BETWEEN THE DRIVER'S BACK AND THE SEATBACK. TO ENSURE THE DRIVERS SAFETY DO NOT OPERATE VEHICLE IF HEADREST HAS BEEN REMOVE.**

**2. Regulation of rear seat**

The regulation of seatback and headrest is the same with that of front seats.

**3.4 Seat Belts**

**1. Seat belts**

Cross the seat belt over your body and press the lock buckle into the socket, until a "click" sound is heard. Press the button on the socket to release the seat belt. The length of the belt can be adjusted automatically through the retractor.

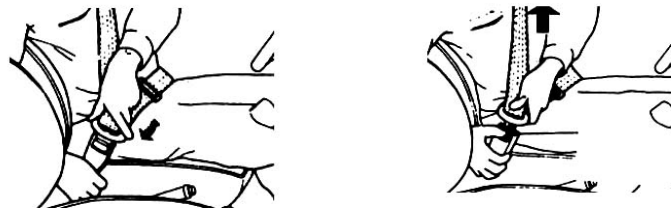

**WARNING!!!**

**ALWAYS REMAIN RESTRAINED WITH SEAT BELT WHILE DRIVING VEHICLE. REPLACE THE BELT WHEN WORN, DIRTY OR DAMAGED. THE SEAT BELT FOR EACH SEAT IS DESIGNED ONLY FOR ONE PASSENGER. MODIFICATIONS ARE PROHIBITED BY LAW.**

**3.5 Switches**

**1. Ignition switch – The four locations of the ignition switch**

**WARNING!!!**

**DO NOT PLACE HANDS THROUGH STEERING WHEEL WHILE OPERATING THE IGNITION.**



**Turn to LOCK**

- **LOCK**

While vehicle is parked, the key can be pulled out from Ignition switch. You can only rotate key to the LOCK position while key is inserted in ignition. After the key is pulled out, the ignition switch and the steering column will be locked. To turn steering wheel, you should insert the key and rotate it to another position clockwise. If you have the trouble unlocking the Ignition switch, turn steering wheel to left or right side gently.

- **ACC**

When the key is rotated to this position, the power of accessories such as the radio will be on, but not engine power

- **ON**

This is the normal position for operation. When the key is rotated to this position, all electric systems will be on

- **START**

When the key is rotated to this position, the engine starts up. As soon as the engine is started, the key must be released from the position.

**WARNING!!!**

**PULLING THE KEY OUT OF IGNITION IS PROHIBITED DURING OPERATION OF VEHICLE.  
PULL OUT THE KEY FROM IGNITION SWITCH AFTER PARKING. NEVER LEAVE VEHICLE  
UNATTENDED WITH KEY IN IGNITION.**

**WARNING!!!**

**IF ENGINE CAN'T BE STARTED WITHIN 5 SECONDS EACH TIME, THEN START IT FOR SECOND  
TIME AFTER 10 SECONDS, OTHERWISE STARTER WILL BE DAMAGED.  
IF ENGINE DOES NOT OPERATE, DO NOT HOLD THE IGNITION SWITCH AT "ON" POSITION  
THIS COULD DAMAGE THE BATTERY.**

**2. Headlights/Lights**

Lighting switch is on the left of the steering column pipe. The operation is as follows:

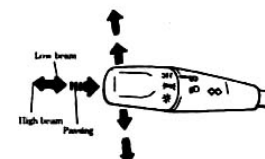
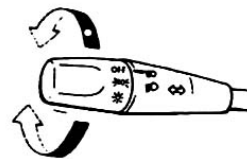

- a) Rotate the end of control lever to control the lighting system. The lighting switch has three positions. When the switch is set to OFF lights are off. When the switch is set to the middle position, the running lights, tail lights, license lights, lighting lights for the combination meter turn on but headlight still off. On the third position, the head light and all of others are on.
- b) When the headlights are illuminating, press down the lighting control lever, the high beam will illuminate and high beams will signal light on the combination meters to also turn on. If you only need the high beam to give a signal for a moment, pull up the lever gently, release the hand it could return to the original position after giving signal

### 3. Turn signal light switch

Turn signal light switch and lighting switch share the same control lever. When the Ignition switch is set to ON, pushing the lever forwards or backwards will result in the right or left side turn signal lights flashing.

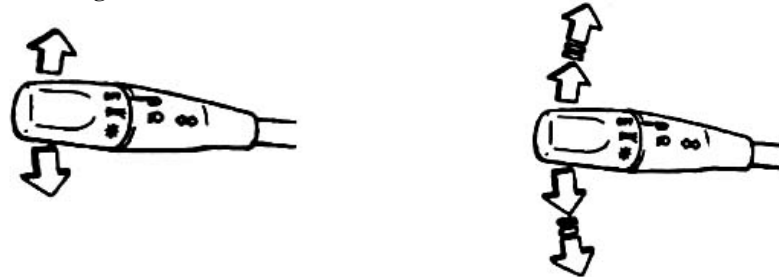

#### 4. Wiper/Washer switch

- The wiper/washer control lever is on the right side of the steering wheel. By placing the wiper's control lever return to one of the three positions, the wiper will begin.
- The INT (intermittent) position is used for mist or slightly rainy weather.
- When the wiper's control lever is on LO position, the wiper will sway slowly and continuously.
- When the wiper's control lever is on HI position, the wiper will sway quickly and continuously.
- Turn the lever to OFF position to stop the wiper.
- The washer for windshield will spray when you push the switch lever up.

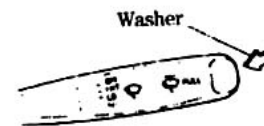
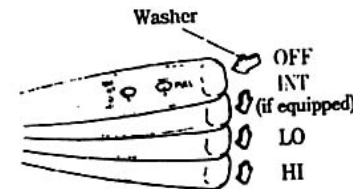

**WARNING!!!**

**TO AVOID THE WINDSHIELD FREEZING, YOU CAN TURN ON THE DEFOGGER TO HEAT UP THE WINDSHIELD BEFORE CLEANING.**

**WARNING!!!**

**TO AVOID DAMAGING THE WIPER AND WASHER SYSTEM, PAY ATTENTION TO THE FOLLOWING:  
NEVER PUT UP THE LEVER WHEN EMPTY. THIS MAY RESULT DAMAGE TO THE WASHER MOTOR.  
NEVER WIPE THE DRY WINDSHIELD. THIS MAY RESULT IN BLADE AND WINDSHIELD DAMAGE.  
ALWAYS WET THE WINDSHIELD BEFORE OPERATING THE WIPER. CLEAN UP THE WIPER BLADE  
BEFORE YOU OPERATE THE WIPER. CHECK THE LEVEL OF THE FLUID REGULARLY, THE  
FREQUENCY OF CHECKING SHOULD INCREASE IN BAD WEATHER. IN COLD WEATHER ADD ONLY  
FILL TANK TO 75% CAPACITY, FLUID WITH EXPAND AT FREEZING TEMPERATURE.**

5. Hazard switch

Press this switch to turn on hazard lights. The six turn signal lights and the two turning indicator lights shall flash. Press this switch again, the warning light signal stops.



**WARNING!!!**  
**IN CASE OF EMERGENCY, PRESS THE SWITCH, THE VEHICLE LIGHT WILL BE ACTIVATED TO ALERT OTHER DRIVERS ON THE ROAD.**

6. Front fog light switch

Press this switch, the fog lights turn on.

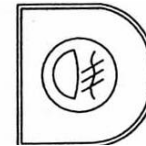

**7. Rear fog light switch**

When the switch of lighting is set to the third position, press this rear fog light switch, the rear fog lights turn on.

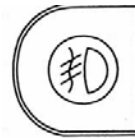

**8. Rear wiper switch**

When the ignition switch is set to the position of “ON”, press this switch, the rear wiper begins to work.

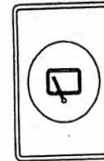

**9. Rear washer switch**

When the ignition switch is set to the position of “ON”, press this switch, the rear washer begins to work.



10. Rear Defogger switch

When the ignition switch is set to the position of “ON”, press this switch, the defogger begins to work.

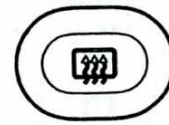

11. Electric window wiper switch

Refer to item 4 for detailed contents.

12. Horn

Pressing the  mark horn button on the steering wheel will result in the horn sounding.

### 3.6 Indication Lights and Dome Lights

#### 1. Brake warning light

When the ignition switch is ON, the light shall be activated immediately. After starting the engine, if the fluid level in the reservoir tank is at normal position, the light shall be off while the brake level is depressed. The light should be on under the following four conditions:

- a) The ignition switch is set to the position “START”
- b) Pulling the parking brake lever up
- c) The braking fluid level falling below the definite level
- d) While driving, if the brake warning light is on, this may indicates that the brake system failed and the following should be done:

IMMEDIATELY PULL OVER SAFELY TO THE SIDE OF THE ROAD. TEST BRAKE PERFORMANCE. AFTER CONFIRMING IT IS SAFE, PROCEED TO THE NEAREST SERVICE STATION AT A LOW SPEED.

**WARNING!!!**  
**BECAUSE THE DISC BRAKE SYSTEM CAN BE ADJUSTED AUTOMATICALLY,**  
**THE FLUID LEVEL WILL DROP WHEN THE BRAKE SYSTEM WEARS.**  
**BRAKING FLUID LEVEL SHOULD BE OF CHECKED REGULARLY.**

## 2. Electronic brake distribution (EBD) warning light

The EBD warning light should illuminate when the ignition switch is turned “ON” and should go off after a few seconds.

**WARNING!!!**  
**IF THE WARNING LIGHT STAYS ON OR DOES NOT ILLUMINATE WHEN THE IGNITION SWITCH IS TURNED “ON” OR IF THE EBD WARNING LIGHT ILLUMINATES DURING DRIVING, THIS IS AN INDICATION THAT THE EBD IS MALFUNCTIONING.**

## 3. Oil pressure warning light

**WARNING!!!**  
**DRIVING WITH THE OIL PRESSURE WARNING LIGHT ILLUMINATED WILL RESULT IN SERIOUS ENGINE FAILURE.**

When the ignition switch is ON, this light shall be illuminated. The light shall be off after starting the engine and while the engine is running, the light illuminated indicates that the oil pressure is dangerously low. Check and refill immediately.

#### 4. Charge warning light

When the ignition switch is ON, the light will be illuminated, and the light shall be off after starting the engine. If the battery system is not fully operational, the light shall continue to be illuminated.

#### 5. Seat belt warning light

This light illuminates when the ignition switch is set to “ON” position and it goes off when fastening the seat belt on the driver’s side.



6. Check engine indication light



After turning the ignition switch on, the light shall be illuminated, and the light shall be off after starting the engine. If the light is on while the engine is running it indicates system failure.

7. Turn-signal indication light

**WARNING!!!**  
**WHEN THE CHECK ENGINE INDICATION LIGHT IS ILLUMINATED WHILE DRIVING, IT INDICATES SYSTEM FAILURE. AVOIDING DRIVING AT HIGH SPEEDS AND HAVE THE SYSTEM CHECKED AS SOON AS POSSIBLE.**

When the side turn signal light is turned on, this indication light shall flash on.



8. High-beam indication light

When the high beam switch is turned on, the indicator light shall be illuminated.



## 9. Dome lights

- 1) Dome light (front Dome light and rear dome light)
- 2) OFF position; the light goes out.
- 3) The dome light goes on when a door (except the tailgate) is opened. When all doors and the tailgate are closed, the dome light goes out.
- 4) ON position -The light illuminates.
- 5) Personal lights (at the front dome light). Push the button to turn on the light. Push it again to turn it off.

**WARNING!!!**  
IF YOU LEAVE THE LIGHTS ON WITHOUT RUNNING THE ENGINE, THE BATTERY WILL LOSE CHARGE. BEFORE YOU LEAVE THE VEHICLE, MAKE SURE THAT THE LIGHTS ARE TURNED OFF.

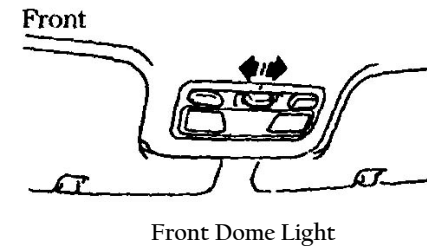

### 3.7 Instruments

#### I. Combination meter

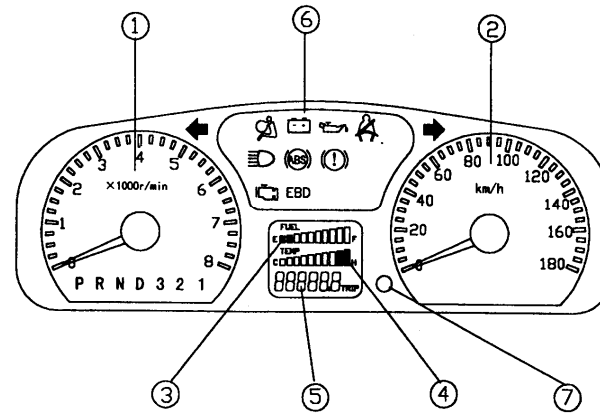

① Tachometer; ② Speedometer(km); ③ Fuel gauge; ④ Water temperature gauge; ⑤ Odometer /Trip meter;

⑥ Warning and indication lights; ⑦ Trip meter reset button

### ① Tachometer

The tachometer indicates the rotate speed of the engine in rpm. During normal travel, the pointer does not rise to the red zone, otherwise it is indicated that the engine RPMs are too high.



### ② Speedometer

- The speedometer indicates the vehicle's speed in km/h;
- The odometer indicates total distance the vehicle has traveled.
- The trip meter indicates the distance traveled of one trip or between two times filling.

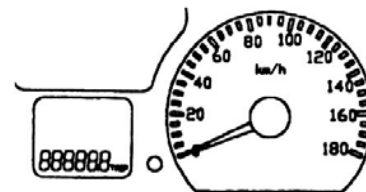

### ③ Fuel gauge

When the ignition switch is “ON”, the fuel gauge shall indicate the fuel level in the fuel tank. “F” stands for full, “E” stands for empty. When the indication is on “E” or in the red area, it means that the fuel is not sufficient in the tank and the fuel must be filled as soon as possible.

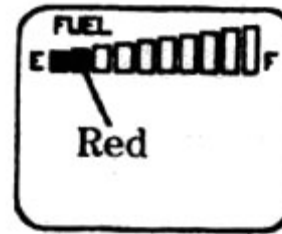

#### **WARNING!!!**

**DO NOT DRIVE WITH LOW FUEL LEVEL. THIS WILL RESULT IN ELECTRICAL FUEL PUMP FAILURE. IT IS RECOMMENDED THAT AT LEAST 8 LITERS OF FUEL BE CONTAINED IN THE FUEL TANK, THIS INCLUDES THE INITIAL FILLING.**

#### ④ Water temperature gauge

When the ignition switch is “ON”, the gauge shall indicate the temperature of cooling water in engine. During normal driving, the temperature of cooling water must be maintained in the normal range i.e. the range between “C” and “H” marks. When the indication is in the red area, it indicates that the engine is over-heated, immediately stop the vehicle and not to start engine until the engine cool.

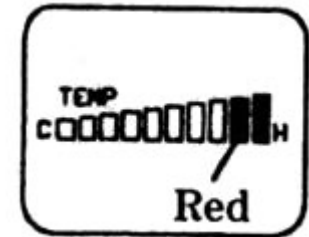

**WARNING!!!**

**DO NOT DRIVE VEHICLE IF ENGINE IS OVERHEATING.**

#### ⑤ Odometer /Trip meter

Odometer will keep accurate mileage for the life of the vehicle. The trip meter will measure individual segments and may be reset.

#### ⑥ Warning and indication lights

Refer to section 3.6.

### ⑦ Trip meter reset button

Every time the reset button is pressed for less than two seconds, indications between odometer and trip meter are changed; to turn the indication of trip meter to zero, press the reset button for more than two seconds.

### 3.9 Cigarette Lighter and Ashtray

#### 1. Cigarette lighter

Set the ignition switch to ACC or ON, Press in on lighter.  
When heated, the lighter will pop out and will be hot

#### 2. Ashtray

Ashtray can be used by pulling out from dash.

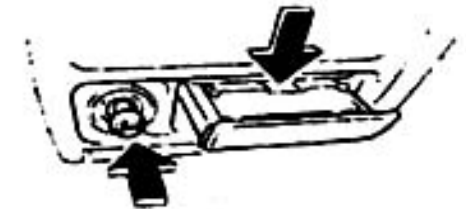

#### **WARNING!!!**

**ALWAYS PUT OUT MATCHES AND CIGARETTES BEFORE THEY ARE PLACED IN THE ASHTRAY. ALWAYS CLOSE THE ASHTRAY. IF LEFT OPEN, OTHER CIGARETTE BUTTS IN THE ASHTRAY MAY BE REKINDLED. NEVER PUT PAPERS AND OTHER FLAMMABLE ITEMS INTO YOUR ASHTRAYS. DOING SO MAY RESULT IN FIRE DAMAGE.**

### 3.10 Air Conditioning

The air conditioner equipped in the vehicle has many functions such as cooling, heating, ventilation and defrosting.

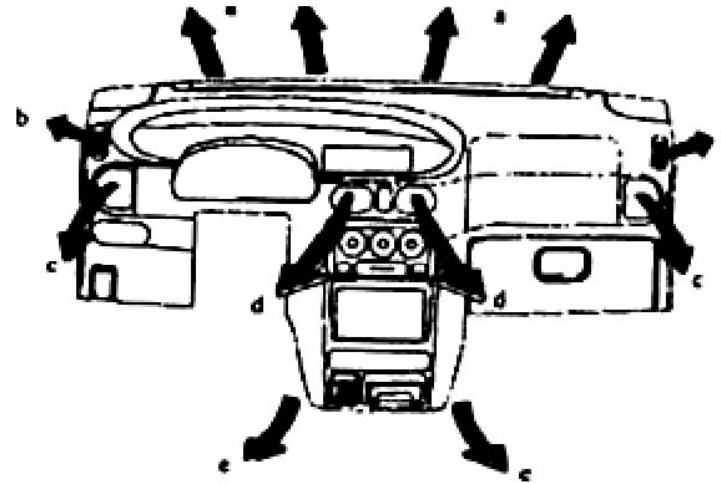

a-From center defogger; b-From side defogger; c-From side ventilator;  
d-From center ventilator; e-From under the instrument panel

1) Mode selection dial is used for choosing one of the following functions:

 (Face position) Air blows from center and side vent outlet.

 (Face/foot position) Heater air blows from foot vent outlet, colder air blows from center and side vent outlet. When the position of the temperature control dial is on “full hot” or “full cold”, the temperature of air is same on all vent outlets.

 (Foot position) Air blows from foot vent.

 (Foot/defogger position) Air blows from foot vent and defogger.

 (Defogger position) Air blows from defogger.

- 2) Blower speed selection dial is used to start the fan and adjust the fan speed. It has four shifting positions: off, low, moderate and high.

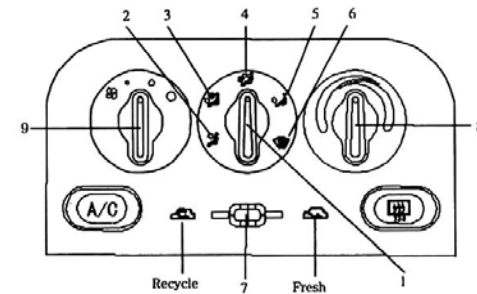

- a. 1-Mode selection dial; 2-Face position; 3-Front/face position; 4-Foot position; 5-Foot/defogger position; 6-Defogger position; 7-Air inlet mode selector; 8-Temperature control dial; 9-Blower speed selection dial
- b. Temperature control dial
- c. Controls the temperature of air blowing.
- d. Air inlet mode selector
- e. Alternates between outside air introduction (Fresh air) and inside air recirculation (Recycle air).

### 1. Air conditioning operational indication

- a) Fresh air ventilation.
- b) Rotate mode selection dial to ventilation area and turn air inlet mode selector to outside air introduction, then turn blower speed selection dial to OFF, the fresh air enter the cab when driving.
- c) Drive ventilation.
- d) Rotating the switch for blower speed selection dial to the position but not “OFF”, other position of dials or levers are the same as nature ventilation’s.
- e) Normal ventilation of heating air (using the outside air)
- f) Turn the mode selection dial to “heating” and dial the air inlet mode selector lever to the “Fresh”, then turn the temperature control dial and switch for blower speed to the position you need. If you want to increase the efficiency of air conditioning, rotate the blower speed to the higher speed.
  - i. Rapid ventilation of heating air (using the recycle air)  
Dial the air inlet mode selector lever to “recycle”, other position of dials are the same as normal ventilation of heating. Using this mode for a long time, the air in the cab will be polluted and window glass will be covered by fog. You’d better dial the air inlet mode selector to the normal ventilation of heating as soon as possible when you use this mode.

- ii. Face cooling/foot warm mode  
Rotate the mode selection dial to face/foot position and dial the air inlet mode selector to “Fresh” position, then turn the temperature control dial and blower speed selection dial to your desire. Except for turning the temperature control dial to the “the full hot ventilator” or “the full cold ventilator”, the air blowing from the central vent and side vent will be colder than from the foot vent.
- iii. Defogger/foot warm mode  
Turn the mode selection dial to foot/defogger position and dial air inlet mode selector to the “Fresh” position, then turn the temperature control dial to what you need and dial the blower speed selection dial to the “high”. After the windscreen is clear, turn the blower speed selection dial to what you need.
- iv. Defogger  
Turn mode selection dial to defogger position and dial the air inlet mode selector to “Fresh”, then turn the temperature control dial to what you need (the higher temperature ,the better results),turn the blower speed selection dial to the “high”. You can turn the blower speed selection dial to what you need after the windscreen is clear.

- v. If your vehicle is equipped with air conditioner, then there is an A/C button at the left side of blower speed selection dial, air conditioning system provides the following functions such as cooling and dehumidify. To turn on the air conditioning system, press the A/C button and turn the blower speed selector dial to the position except “OFF”. Turn on the air conditioning system causes the indicator light to illuminate. Press the A/C button once more to turn the system off.
- vi. When using the air conditioning, the rotate speed of engine may slightly change, the change is normal; the air conditioning compressor is switched on/off automatically. To maintain the selected temperature, reduce compressor work, then fuel can be saved.

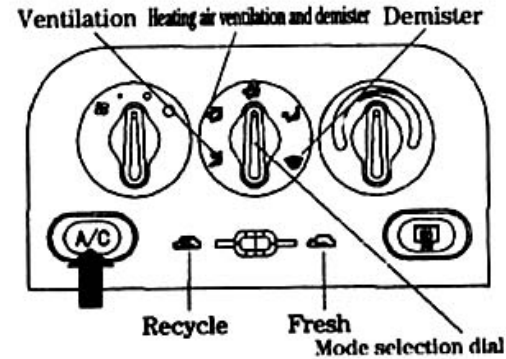

## **2. Air conditioning cooling system**

The cooling system in your vehicle is of center air conditioning system consists of one condenser and two evaporators. The cool air blows from ventilators of the instrument panel inlet and the upper air conditioning ventilators, there are two blower speed switches: One is the blower speed selection dial fixed on the heater air blower controls panel, which control the air conditioning start and air blows from the front evaporator; the other is the upper evaporator blower switch, which adjusts the air blower, from the upper air vent.

## **3. To start the air conditioning**

Set the temperature control dial around the maximum cool position, turn on the air conditioning switch, then operate the blower speed selection dial on the heater air blower control panel, at the moment, the engine speed may slightly change, the change is normal. After starting the air conditioner, select the front evaporator or the upper evaporator and adjust the blower to fit your needs.

## **4. Dehumidifer**

Close the vent of the upper evaporator, turn on the air conditioning switch, turn the temperature control dial to the heater air area, set the blower speed selection dial fixed on the heat air control panel to what you need, now it can dehumidify.

### 5. Rapid cooling (using the recycle air)

Besides dialing the air inlet mode selector to the “Recycle” turn other dials to the normal, if you have used this mode for a long time, the air in cabin can be polluted, so you should dial the air inlet mode selector to “Fresh”.

### 6. Precautions during operation of air conditioning

- 1) Park the vehicle in the shade. Parking in the hot sun will make the vehicle inside extremely hot, and it will require more to cool the interior. If it is necessary to park in the sun, open the windows for the first few minutes of air conditioning operation to expel the hot air.
- 2) When the cooling system is opening, rotate temperature control dial to the blue area and dial air inlet mode selector to “Recycle”. If the cooling system has been opened for a long time, you should often put the air inlet mode selector on "Fresh".
- 3) If the blower speed selection dial has been turned to the "low" for a long time, the compressor often cut off for temperature on the outlet is low. This is because that the air conditioning is adopted the safeguard against the evaporator frosting.
- 4) When you drive the vehicle in low speed, reduce one shift to increase the rotate speed of engine. If you drive the vehicle carrying heavy in low speed, reduce one shift to increase the rotate speed of engine and improve cooling system, lest over loading and preventing the temperature of engine from high.

- 5) When you have used air conditioning for a long time in the sun and the water temperature indicator shows water in the engine is over-heated, turn off the air conditioning for a while.
- 6) If the air conditioning has not been operated for a long time in the winter, you should operate it for 5 minutes every two weeks. It can prevent the refrigerant from leaking and protect the air conditioning.
- 7) Always use preferred refrigerant HFC-134A. Do not mix with other refrigerant.

### 3.11 Glove Box

To open, pull the lever. To close, push the lid down until it's locked.

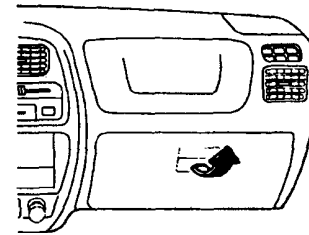

**WARNING!!!**  
**ALWAYS KEEP THE GLOVE BOX LID CLOSED WHILE DRIVING TO AVOID**  
**INJURY IN AN ACCIDENT.**

### 3.12 Radio and Tape Player

The vehicle is equipped with AM/FM electronic tune tape radio player. The radio can be operated when the ignition switch is at “ON” or “ACC” position.

### 3.13 Parking brake lever

The parking brake lever is located in the middle of the front seats. To use, depress the brake pedal and pull up parking brake lever. To release, depress the brake pedal, and then pull up the parking brake lever a little, and use your thumb to press the knob on the end of the parking brake lever to the original position. If you want to inspect whether the parking brake whether adjusted correctly or not, you should pull up the lever to parking position slowly.



**WARNING!!!**  
**RELEASE PARKING BRAKE LEVER DURING VEHICLE DRIVING, OTHERWISE BRAKING PERFORMANCE OF REAR BRAKE WILL BE REDUCE DUE TO OVERHEATING. THIS CAN DRASTICALLY SHORTEN THE LIFE OF THE BRAKES.**

### 3.14 4WD Operating Instructions

- 1) Engage the High-Low gear application:
  - Ensure that the vehicle is not moving before engaging the Hi or Low application.
  - The Hi-Low Lever is located below the gear shift.



- 2) High Gear:
  - Ensure that the vehicle is at a complete stand still.
  - Shift the lever to the left or toward the driver's side until you feel a click.
  - Hi gear is now engaged and ready to use.

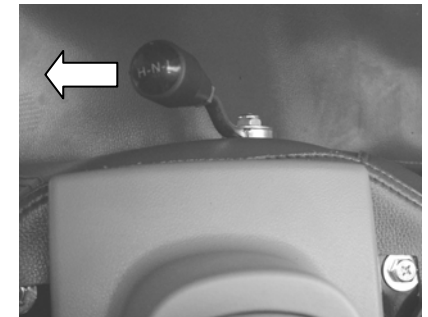

3) Low Gear:

- Ensure that the vehicle is at a complete stand still.
- Shift the lever to the **right** or toward the passenger's side until you feel a click.
- Hi gear is now engaged and ready to use.

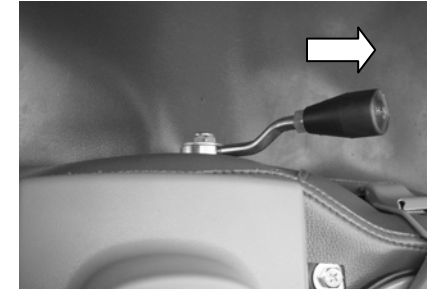

4) 4WD or 2WD Switch:

- This switch is located on the right side of the dash next to the recirculation control.

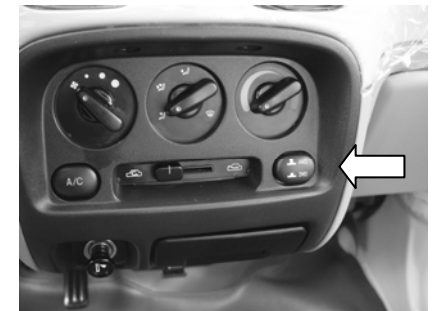

5) Operating in 4WD or 2WD:

- The button will be set in the “OUT” position when 4WD mode is engaged and in the “IN” position when 2WD mode is engaged.
- To switch to 4WD, the vehicle can be in motion, but at a speed of no more than 10 miles per hour. Switching at higher speeds will cause damage. 4WD mode is best used for Off Road terrains, and engaging 4WD on asphalt is NOT recommended.
- To switch to 2WD, the vehicle can be in motion, but at a speed of no more than 10 miles per hour. Switching at higher speeds will cause damage. 2WD mode is best used on asphalt roads.

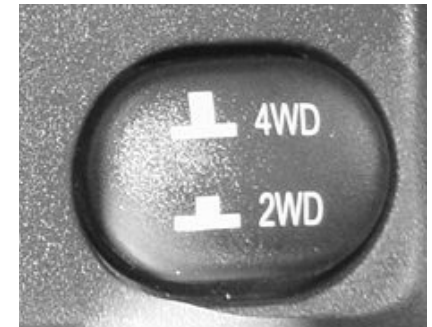

## 4) DRIVING

**\*\*\*FOR AUTOMATIC TRANSMISSION, SEE ADDITIONAL DOCUMENTATION PROVIDED WITH THE VEHICLE.\*\*\***

### 4.1 Exhaust Emissions and Restraining Devices

The vehicle equipped with engine management system has exhaust purifying system, harmful emission CO, HC and NO<sub>x</sub> produced by engine work will be oxidized and reduced in efficiently. Operation of this system can make harmful gas emissions we meet the requirements of state environment protection and emission regulations. A catalytic converter is installed between the exhaust pipe and silencer assembly. An oxygen sensor is fitted on the exhaust manifold.

**WARNING!!!**  
**AVOIDED WATER CONTACT ON OXYGEN SENSOR AND HARNESS. AVOID HIGH TEMPERATURE AND FRICTION.**

In order to avoid possible damage to the catalytic converter, notice the following during driving:

- a) The vehicle must use 89octane and above. Using quality unleaded gasoline will help avoid poisoning of oxygen sensor and catalytic converter.
- b) In case the ignition system fails, power is reduced to avoid possible damage. In this case, please take vehicle to a maintenance center as soon as possible.

- c) Frequent starting of vehicle by pushing and towing the vehicle should be avoided, and an auxiliary battery should be used for starting.
- d) It is prohibited to idle the engine at removing spark plug connection, when checking the engine.
- e) Avoid excessive idling of the engine.
- f) Avoid driving on an empty gas tank.
- g) The vehicle should be checked and maintained in maintenance center. If engine exhaust purifying system is involved, it is recommended to have the vehicle checked.

#### **4.2 Inspecting Items Before Daily Use**

- a) The windows, rearview mirror and lights should be clean and unobstructed.
- b) Inspect tire conditions.
- c) Inspect oil and water
- d) Adjust the positions of seat and headrest.
- e) Inspect the braking and clutch pedals.
- f) Inspect the working conditions of turn-signal lights and illumination lights and horn.
- g) Inspect every kind of the indicator dials.
- h) Driver and passenger must fasten seat belts before drive.

#### 4.3 Vehicle Driving Notice

**WARNING!!!**

**DO NOT DRIVE THE VEHICLE IN EXCESS OF 40KM/H ON UNEVEN SURFACE ROADS. DO NOT DRIVE THE VEHICLE FOR EXCESS OF TIME CONTINUOUSLY ON UNEVEN SURFACE ROADS. THIS MAY RESULT IN DAMAGE OF TRANSMISSION SYSTEM AND TIRES.**

#### 4.4 Engine Starting

- 1) Vehicle parking brake is on.
- 2) Put shift knob in neutral gear position.
- 3) Never apply accelerator while ignition key is in "START" position. If engine cannot be started then spark plug short circuit failure was caused by gasoline overflow of the engine. At this time, fully depress accelerator and start the engine (system cut off the gasoline supply) for 5-6 seconds, high speed airflow will blow down the gasoline overflow, then release the accelerator and start the engine again.

**WARNING!!!**

**ONLY ATTEMPT IGNITION START FOR 5 SECONDS, REPEAT AFTER WAITING 10 SECONDS. OTHERWISE THE STARTER MAY BE DAMAGED AND FUEL INJECTION AND ELECTRICAL SYSTEM SHOULD SYSTEM MUST BE INSPECTED.**

## 4.5 Operation of Transmission

### 1. Gear shifting

Calcium lubricant is recommended for use of shift lever assembly.

a) To start vehicle for manually shifted transmission:

- Depress clutch pedal, shift the knob in first position, release the parking brake lever, and release the clutch slowly, depress accelerator pedal slowly, at the same time, releasing clutch.

b) Completely depress clutch pedal when changing gears.

c) Avoid allowing engine to be in high speed when changing gears and starting engine as this will shorten life of the engine.

d) All forward gears have the synchronizer, speed and gear can be easily changed.

e) Always keep engine speed within a certain range to save fuel and extend vehicle life.

#### **WARNING!!!**

**CONTINUOUS DEPRESSION OF CLUTCH WILL RESULT IN DAMAGE OF THE CLUTCH  
AVOID PROLONG ENGINE IDLE WHICH MAY RESULT IN DECREASED LIFE OF THE  
ENGINE.**

#### 4.6 Braking

Brake is the device to make the vehicle slow down and stop; the brake distance will be long if the speed of the vehicle is high. For example, the brake distance in 60km/h is fourfold of that in 20km/h. which allows vehicle to slow as brake pedal is depressed.

**WARNING!!!**  
**WHEN VEHICLE IS DRIVEN IN WATER OR AFTER THE VEHICLE IS WASHED, IT SHOULD BE DRIVEN IN LOWER SPEED OR BY DEPRESSING BRAKE PEDAL. THE BRAKE SHOULD BE CLEANED TO AVOID EXCESSIVE WEARING AFTER EXPOSURE TO MUD, SAND OR WATER AND ACCUMULATED ROAD SURFACE. AVOID DEPRESSION OF BRAKE PEDAL WHEN THE TIRE PRESSURE IS LOW.**

Brake distance is different according to road situation, especially vehicle runs in high speed in rain day will form water layer phenomenon (high speed running on the water accumulated road, If vehicle speed exceed a speed, tires will not remove water on the road, thus form skidding state and lose to control on water road.) And generate the phenomenon of no braking efficiency as driving on water road. So notice specially to drive safely in rain day .The more serious tires worn, the higher vehicle speed or the more water on the road, water layer phenomenon is formed easily.

- After running on snow road, clean away snow and mud on the tires as soon as possible.
- Four wheels must use assigned tires in the same specifications. Variation from specifications will influence braking performance.

#### 4.7 Clutch, Brake and Accelerator

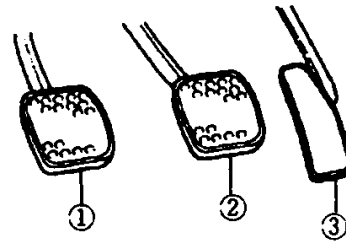

##### 1. Clutch

Depress clutch pedal as the No. 1 in the figure, can depart the output engine power from the tires, depress the clutch pedal when start up engine and change into other gear.

**WARNING!!!**  
**EXTENDED USE OF CLUTCH CAN RESULT IN A PREMATURE WEARING OF CLUTCH ASSEMBLY.**

## 2. Brake

- a) The vehicle is equipped with front disc brakes and rear drum brakes. Depress the braking pedal (marker 2); all the brakes will work. Free stroke of braking pedal is 3-8mm.
- b) If shrill noise is heard while depressing on the braking pedal, maybe it is normal because of environment like coldness, dampness, or snow weather.

Start the engine, step on braking pedal at 30kgf, the distance “B” from pedal to floor not be less than 145mm, the distance measure does not include the thickness of floor cushion.

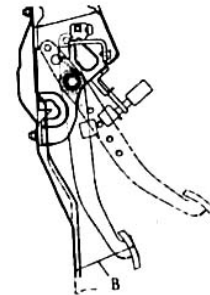

## 3. Accelerator

The accelerator pedal (marker 3) is used to control the rotation speed of the engine. When depressing the accelerator pedal, the engine rotation speed and output power will increase.

#### 4.8 New Vehicle Driving

Speed should be controlled within initial 2500km driving mileage; to make all movable parts and components of the vehicle fully run-in, performance and reliability of the vehicle can be given play to most extend in future. Therefore the following principle should be abided:

Gear position	N
First gear	10km/h
Second gear	20km/h
Third gear	25KM/H
Fourth gear	25KM/H
Fifth gear*	25KM/H

- 1) Each speed should not exceed the max speed that is recommended in the table above.
- 2) Allow the engine to gradually warm up after starting.
- 3) The vehicle should be driven on flat and good road surface and driving on bad road such as the mud, sand and steep slope should be avoided as practically possible.
- 4) Gear should always be changed when breaking, do not go at same gear position for long period.
- 5) Abrupt and unnecessary braking, sudden accelerating and emergency braking should be avoided
- 6) Engine coolant temperature and oil pressure should be checked periodically

#### 4.9 High Speed Driving

**WARNING!!!**

**DRIVER AND PASSENGER MUST USE SEAT BELT AT ALL TIMES.  
FOR CORRECT APPLICATION REFER TO SAFETY BELT CHAPTER.**

- 1) When braking at high speed, the distance to stop will increase with speed, in order to assure safety, it is necessary to brake ahead of time.
- 2) When raining, moisture film will formed between tire and ground surface, which will cause hydroplaning of vehicle. Use caution while driving on wet surface.
- 3) Use caution while driving at high speed, in tunnels, during high wind conditions or wet road surfaces.

#### 4.10 Driving on Special Roads

##### 1. Driving on a sloping road

- a) You must shift to lower speed while climbing steep grade.
- b) Reduce the shifting position and use an engine brake to while proceeding down steep grade.

**WARNING!!!**  
**WHEN DRIVING VEHICLE DOWN STEEP GRADE, AVOID BRAKING REPEATEDLY. FAILURE TO DO SO CAN RESULT IN OVERHEATING OF BRAKE. REDUCE SPEED AND SHIFT TO LOWER GEAR. ALLOW ENGINE TO IDLE AFTER YOU DRIVE YOUR VEHICLE UP A STEEP GRADE.**  
**NEVER SHUT ENGINE DOWN IMMEDIATELY AFTER STEEP GRADE CLIMB.**

**2. Driving on wet/dangerous road conditions**

When driving on wet, snowy or muddy surface brake may slip.

a) Antiskid chain on wheel

Inspect the dimensions of the chains and the wheels, and then tighten the chain firmly on the front wheels. After assembly, check the gaps between the wheels and the anti-splash guard, drive 1 kilometer at a low speed, then check whether the chains are firm so as to ensure safety.

b) Vehicle stuck in snow

When shifting, release the accelerator. If you continue depressing the accelerator, the tires may turn which will increase your inability to move out of these conditions.

**Your vehicle may need to be towed if the above methods are not useful.**

**WARNING!!!**  
**TO AVOID WATER ENTERING THE AIR INTAKE SYSTEM, DO NOT DRIVE VEHICLE THROUGH DEEP OR UNSAFE WATER LEVELS.**

#### 4.11 Cargo and towing/passenger

The weight of cargo and the number of crew must not exceed the permissible limit.

**WARNING!!!**  
**TO AVOID INJURY TO THE PASSENGER AND DAMAGING THE VEHICLE, ANY  
CARGO SHOULD BE LAID SYMMETRICALLY AND TIED SAFELY.  
PREVENT CARGO FROM MOVING DURING VEHICLE OPERATION.  
CARGO HEIGHT MUST NOT EXCEED SEAT LEVEL.**

##### **1. Towing**

Towing can only be done by an authorized towing company. While towing other vehicle the towing rope should be tied to the hook.

**WARNING!!!**  
**DO NOT TRY TO TOW A VEHICLE WHICH IS HEAVIER THAN ITSELF.**

## 5) EMERGENCY CONDITIONS

### 5.1 Engine Overheat

- a) High temperature gauge will illuminate if vehicle is overheating.
- b) Turn off air conditioning.
- c) The vehicle must be parked.
- d) Let the engine race in normal speed for several minutes, the water temperature meter will fluctuate between “H” and “C”.
- e) If the water temperature gauge does not drop, stop the engine and check whether the belt and belt wheel is destroyed or is slipping.
- f) Check the coolant tank to verify coolant level is not below “LOW” and whether there is leakage in each water hoses.
- g) If coolant level is below “LOW”, fill to appropriate level.

**WARNING!!!**

**IF STEAM IS COMING FROM THE ENGINE, DRIVE THE VEHICLE TO A SAFE LOCATION AND STOP THE ENGINE. DO NOT ATTEMPT TO OPEN RADIATOR CAP UNTIL ENGINE HAS COMPLETELY COOLED.**

## 5.2 Vehicle Towing

If you want to tow the vehicle please use a professional towing service.

**WARNING!!!**  
TO AVOID DAMAGE TO THE VEHICLE WHEN TOWING, PLEASE USE WING  
EQUIPMENT AND TOW WITH CORRECT METHOD. ON MANUAL  
TRANSMISSION VEHICLE, DO NOT ALLOW THE WHEELS TO COME IN  
CONTACT WITH ROAD WHILE TOWING AS THIS WILL RESULT IN DAMAGE  
TO VEHICLE.

To properly tow a manual transmission vehicle, hang the rear wheels and the front wheels and turn the ignition key to “ACC” position, DO NOT lock the steering wheel.

## 5.3 Assistance Emergency

If the engine does not start, please operate as follows:

- a) Turn on the light switch and turn the ignition switch to “START” position. If the headlights do not illuminate, the power of the battery is not charged or the battery connectors are defective. Inspect the fuse.

## 6) DO IT YOURSELF

### 6.1 Tools Included with Vehicles

Tools along with the vehicle include wheel spanner, two spanners of sizes 8×10mm and 12×14mm, dual screwdriver, spark plug spanner and rocking arm. These tools are located in the workbasket which can be used during maintenance and inspection of the vehicle. The manual jack can be raised by using the rocking arm and wheel spanner.

### 6.2 Use of the Jack

- a) Park the vehicle on horizontal and hard ground.
- b) Pull the parking brake lever up and push the gear shift lever to reverse position and withstand the lifting wheels on the cross.
- c) Turn on the hazard switch.
- d) Place the jack underneath vehicle and vertically raise the vehicle.
- e) Smoothly and slowly operate the jack to appropriate height.

### 6.3 Changing the Tire

The spare tire lies under the left floor between the front and rear wheels.

- a) Loosen the spare tire screw.
- b) Drop the fixing bracket slowly.
- c) Remove the spare tire.

**WARNING!!!**

**THE JACK CAN BE ONLY USED TO REPLACE WHEELS. AVOID USING JACK ON STEEP GRADES OR DOWNWARD GRADES. ENSURE THE JACK IS LIFTED TO 51 MM SO THE JACK IS IN CONTACT WITH FRAME CONVEX PLATFORM. DO NOT WORK UNDER THE VEHICLE WHILE IT IS RAISED BY THE JACK. DO NOT START THE ENGINE WHEN THE VEHICLE IS RAISED BY THE JACK.**

**1. Replacing the Wheels**

In order to make the tire evenly wear and prolong their life, wheel positions should be changed every 10,000km. The alternate method is shown in figure depicted in regular maintenance schedule. After that, adjust the front and rear tires' pressure according to tire pressure instructions.

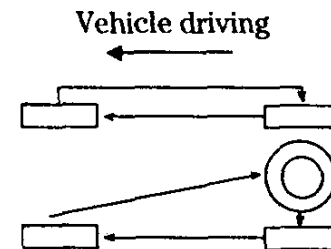

## 2. Changing the Tire

Replace the wheels as follows:

- a) Take out the jack, tools and spare tire from the vehicle.
- b) Loosen the nuts but not removed.
- c) Jack the vehicle.
- d) Remove the wheel nuts and tire.
- e) Install the new tire and wheel nuts which are faced with conical side to the wheel, tighten wheel nuts by hand, and then fasten the wheel to hub.
- f) Lower the jack and tighten all nuts crossly with wheel nut spanner according to the figure.
- g) The torque of nut: 80 - 90Nm

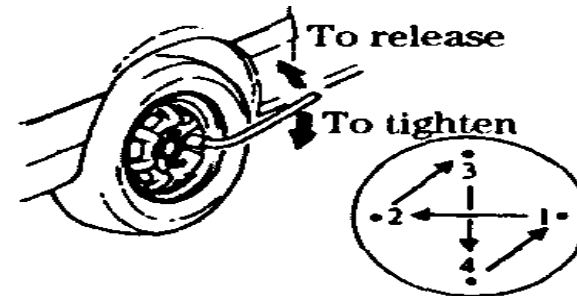

The tire should be checked with tire pressure gauge as follows:

Item	165/70R13 (155R13LT、 155R13C) unloaded	165/70R13(155R13LT、 155R13C) loaded
Front wheel	210 ( 200 ) ±10kPa	230 ( 220 ) ±10kPa
Rear wheel	210(200)±10 kPa	300 ( 350 ) ±10kPa

#### 6.4 Spark Plug

Spark plugs should be changed every 10000km. Replacement type is DK7RTC (DA465Q-16MC engine) F6TC (other engines), and screw is M14×1.25. The surface between central pole insulator and external pole should be clean without carbon deposit which can be eliminated by fine sand paper. The clearance of spark plug is 1.0 1.2mm, and the clearance should be symmetrical and same on whole central pole surface

## 6.5 Fuses

When lights and electrical equipments fail, replace the fuse

- Three fuse housings are installed on your vehicle.
- The first is identified as the class fuse housing.
- There are two fuses in it, one is to protect the positive (+) terminal of the battery from short circuit, and the other is to prevent the output terminal of the generator from short circuit. The fuse housing is located in the engine compartment near the battery.

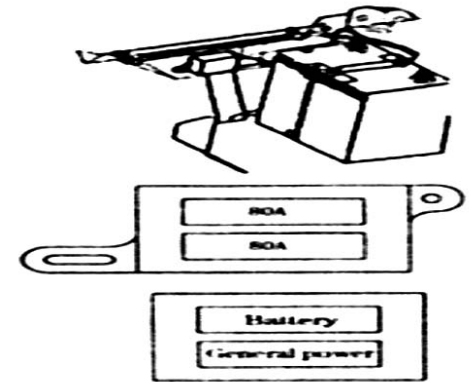

The second class fuse housing: There are some fuses which are intermediate between the first class and the third class fuses, and some fuses to protect some lights, and some fuses to protect the electrical equipments of large power consumption in it. The fuse housing is located in the left-upper area of the front compartment.

- |                 |                  |
|-----------------|------------------|
| 1) Main power   | 6) Condenser fan |
| 2) Lighting     | 7) Main relay    |
| 3) ABS          | 8) Radiator fan  |
| 4) Headlight RH | 9) ABS           |
| 5) Headlight LH |                  |

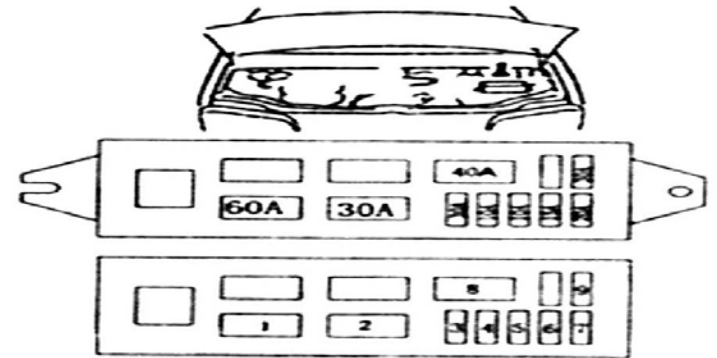

The third class fuse housing: The fuse housing is located at the right side of the steering column in the instrument panel.

Ignition system

- |  |                                |  |
|--|--------------------------------|--|
| 1) Ignition system                     | 8) Rear window defogger        | 14) Position lights and tail lights, LH/background light |
| 2) ECM canister cleaning valve         | 9) Heater                      | 15) Position lights and tail lights, RH                  |
| 3) Oxygen sensor                       | 10) Electric regulator         | 16) Front fog lights, rear fog lights                    |
| 4) Alternator/guage/ABS-ECU            | 11) ECM diagnosis connector    | 17) Hazard lights, stop lights, dome lights              |
| 5) Reversing lights/turn-signal lights | 12) Horn                       | 18) Wiper, washer  |
| 6) Oil pump                            | 13) Gauge, radio, speed sensor | 19) Radio, cigarette lighter                             |
| 7) Compressor/evaporator               |                                |  |

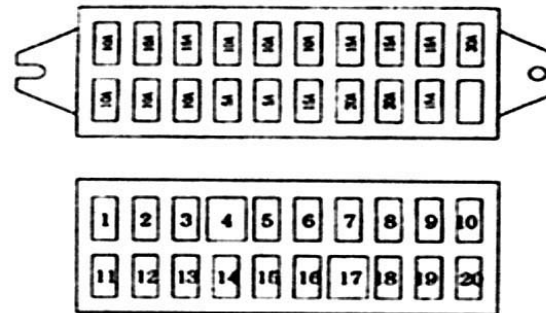

**WARNING!!!**  
**THE FUSE MUST HAVE THE SAME CAPABILITY AS THE REPLACED ONE.**  
**NEVER USE METAL WIRE TO REPLACE THE FUSE.**

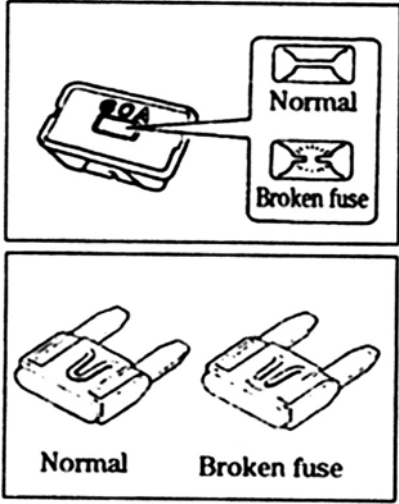

## 6.6 Replacement of Light Bulbs

### WARNING!!!

THE BULBS REMAIN HOT AFTER LIGHTS ARE OFF, SPECIFICALLY HALOGEN BULBS. COMPRESSED HALOGEN GAS IS IN THE HEAD LIGHT'S BULBS. IF THE BULBS FALL DOWN OR BREAK BY KNOCKING, THEY MAY BURST CAUSING SERIOUS INJURY. DO NOT TOUCH BULBS SURFACE WHEN REPLACING.

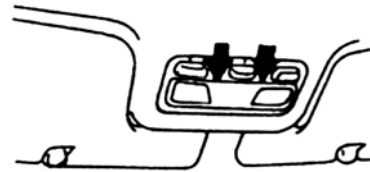

### 1. Installing dome light bulb

Using a flat head screwdriver wrapped with a soft cloth, safely remove bulb.

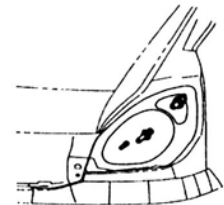

## 2. Head lights

Open the hood, press the lock handle release connector, rotate the light base counter-clockwise. After installation of new light, reinstall the light base, and connect the connector.

## 3. Tail lights (reversing lights/stop lights/position lights/turn-signal lights)

- a) Driver dome lights: Press the reeds according to the arrow shown in figure.
- b) The bulbs in these lights are circular shape or egg shape. To remove or install the egg shape bulbs, just pull out or push in.
- c) To take out the circular bulbs from the base, you should handhold and rotate bulbs in counter-clockwise direction then pull out the bulbs. The bulbs can be installed by pressing and rotating in clockwise direction.
- d) To take down the base from the light cover, rotate the base counter-clockwise then pull out the base, to install the base into the base and twist to secure.

#### 4. Specifications of bulbs

	Item	Parameters (W)
Outside	Head light (halogen bulb)	60/55
	Running lights (in the head light)	5
	Stop light /running light(in the tail light)	21/5
	Reversing light (in the tail light)	21
	Front turn signal light(in the head light)	21
	Side turn signal light	5
	Rear turn signal light(in the tail light)	21
	License light	5
	Front fog light	55
	Rear fog light	21
Inside	Front dome light	7.5
	Rear dome light	8

## 7) INSPECTION AND MAINTENANCE

### 7.1 Safety Note About Inspection and Maintenance

- a) To insure the normal use of vehicle, periodic maintenance is necessary.
- b) It is hazardous to your health, life and safety to allow the vehicle run at idle speed in an enclosed area.
- c) Keep hands, cloths, tools away from the running belt of water pump when the engine running.
- d) Avoid contact with parts of the exhaust system (exhaust manifold, exhaust pipe, muffler, etc.).
- e) Do not smoke near the fuel tank and battery.
- f) When the vehicle is lifted with the jack, it is necessary to support the vehicle with under props before entering into underside of vehicle body.
- g) The battery and high-voltage cable work with high voltage, never short-circuit battery from positive to negative. Keep the terminals and connections tight to avoid sparks and fire.
- h) The engine adopts a multi-point electronically-controlled gasoline injection system. The pressure of the feed line is a high inlet/return hose and must use a high pressure hose and clip with clamp. The joints must be checked for leakage. When checking fuel line DO NOT start engine to check fuel pump.
- i) Avoid contact with oil, coolant and the other liquid which is exchanged. Dispose the exchanged oil, coolant and the other liquids properly. DO NOT pour in drain.

### **1. Instrument and indication lights**

- Turn the ignition switch to “ON” position, check if each indication light illuminates and if fuel gauge works normally. Inspect each indication light and water temperature gauge.

### **2. Lighting system**

- Turn the ignition switch to “ON” position, check if headlights, position lights and other lights turn on. Depress the brake pedal, the stop light should illuminate. Put the gear shift in “R” (Reverse) position, the reverse light should illuminate. Each light cover should be clean and without damage.

### **3. Horn, turn-signal lights, wiper, washer, washer fluid**

- Check if horn, turn-signal lights, wiper, washer work properly.

### **4. Door locking device**

- Check door locking device, it should be secure.

### **5. Rear view mirror**

- Check if rear view mirror is clear, and position is proper.

## 6. Suspension system

- a) Inspect suspension spring for abrasion, breaks or damage. Replace if necessary. Check fastener for tightening to specified torque if necessary. Check the damper for leaks and the damper tube for damage.
- b) Inspect the color of exhaust. If the color of exhaust is too white or too black, there is engine failure. It is normal that the exhaust turns white smoke when the weather is cold.
- c) Inspect the engine blower, fan, relay and capacity of coolant.
- d) Inspect engine oil, oil filter, transmission oil, differential oil.
- e) Inspect the exhaust system of engine.
- f) Inspect air cleaner.
- g) Inspect fuel tank cap and fuel line, fuel filter, charcoal canisters.
- h) Inspect spark plugs.
- i) Inspect engine harness and terminal, high-tension ignition wire, battery, fuse.
- j) Inspect PCV valve.
- k) Inspect work state of the transmission shift mechanism and cable, parking braking control device and cable.
- l) Inspect drive shaft and wheel.
- m) Inspect brake line, brake fluid, gap between brake disc and caliper, and gap between drum and hose. Check that the stroke of the clutch pedal, brake pedal and accelerator pedal moves freely.

- n) Inspect steering system.
- o) Inspect door hinge.

### 7.2 Daily Check and Maintenance

1) The work state of steering gear.	10) Work condition of illuminated device.
2) The work state of brake.	11) Work condition of indication lights and instrument.
3) Tire condition.	12) Rear view mirror and license plate.
4) Engine oil capacity.	13) Work condition of horn and turn-signal lights.
5) Engine coolant capacity.	14) Fuel capacity in the fuel tank.
6) Brake fluid capacity.	15) Battery electrolyte quantity.
7) Engine blower and water pump belt.	16) The gap about clutch pedal, brake pedal.
8) Washer fluid quantity of windscreen.	17) The work state of transmission shift mechanism and parking brake control device.
9) Door locking device.	

### 7.3 Periodic Inspection and Maintenance Schedule

#### Inspection and maintenance schedule

Maintenance schedule should be determined as per speed mileage meter reading or month numbers whichever is first reached		km×1000	2.5	10	20	30	40	50	60	70	80
		Month numbers	2	6	12	18	24	30	36	42	48
<b>Engine</b>											
1	Water pump belt (tension and wearing)	A	—	I	—	R	—	I	—	R	
2	Synchronous indented belt (damage and aging)	I	—	I	—	I	—	I	—	I	
3	Clearance of inlet valve and exhaust valve	A	—	A	—	A	—	A	—	A	
4	Tightening torque for manifold mounting bolts and nuts, cylinder head bolt	T	—	T	—	T	—	T	—	T	
5	Engine oil filter	R	R	R	R	R	R	R	R	R	R
6	Engine oil	Change it every 5000km, if driving on bad sand road surface, check should be often conducted and changed in time									

7	Fuel hoses and connectors (rubber hoses ageing, connectors crack, damage or loose)	I	I	I	I	I	I	I	I	I
8	Rubber hoses and connectors of engine cooling system (water leakage and damage)	—	—	I	—	—	I	—	—	I
9	High pressure harness (aging and damage)	—	—	I	—	—	I	—	—	I
10	Spark plug	—	R	R	R	R	R	R	R	R
11	Air filter	Clean it every 10000km for bituminous road surface and clean it every 2500km for dust road surface								
12	Acceleration cable assembly and throttle body shaft	—	I-L	I-L	I-L	I-L	I-L	I-L	I-L	I-L
13	Fuel filter	—	—	—	—	R	—	—	—	R
14	PCV valve	—	—	I	—	I	—	I	—	I
15	Clutch gap	I	I	I	I	I	I	I	I	I
16	Transmission gear oil (check the leakage under level condition)	R	I	I	I	R	I	I	I	R

17	Check wiring harness for damage, connecting and grounding for security	I	I	I	I	I	I	I	I	I
18	Engine coolant	—	—	—	—	R	—	—	—	R
19	TWC	—	—	—	—	—	—	—	—	I
20	Rocker arm cover venting hoses and connectors	—	—	I	—	—	I	—	—	I
21	Crankcase venting hoses and connectors	—	—	I	—	—	I	—	—	I
22	Tightening torque for knock sensor	A	A	A	A	A	A	A	A	A
23	Distributor cap and distributor track(wearing and aging)	—	—	I	—	—	I	—	—	I
24	Canister	Change it every 50000km, for adverse environment, check should be often conducted, if lockage or liquid fuel immersed is found, then change it in time.								
Chassis and body										
25	Clutch pedal stroke	I	I	I	I	I	I	I	I	I
26	Braking disc and braking lining (abrasion and damage) Braking shoes and braking drum (abrasion and damage)	—	I	I	I	I	I	I	I	I

27	Braking hose and braking pipe (leakage and damage and shriveled)	—	I	I	I	I	I	I	I	I
28	Braking fluid (level and leakage)	I	I	I	I	R	I	I	I	I
29	Brake pedal (distance between the pedal and the front floor)	I	I	I	I	I	I	I	I	I
30	Parking control lever and cable (stroke and damage)	I	I	I	I	I	I	I	I	I
31	Tire (abnormal wearing, pressure)	—	I	I	I	I	I	I	I	I
32	Wheel, nut (damage, torque)	I	I	I	I	I	I	I	I	I
33	Damper (leakage, damage)	I	I	I	I	I	I	I	I	I
34	Parallel shaft (damage, relax)	—	—	I	—	I	—	I	—	I
35	Differential (leakage and oil height)	R	I	I	I	R	I	I	I	R
36	Suspension (loose, damage, click, damage)	I	I	I	I	I	I	I	I	I
37	Test run	Test run after examine and repair								
38	Connectors of wiring harness, illumination lamps and turn-signal lights	—	—	I	—	I	—	I	—	I

This table is applied for the model installed with the electric fuel injection engine DA465Q-1A supplied by UAES.

**Note:** Symbols in table above:

A – Check or adjustment

R—Replace

I – Inspection, adjustment or change should be conducted if necessary

T – Tighten the torque with special wrench to check

L – Lubrication

Rigorous road driving periodic maintenance table

Maintenance item	Rigorous road code	Maintenance schedule
Engine oil and oil filter	A, C, D, E, F	Replace: every 5,000km or 3 months
Air filter	C	Clean: every 2,500km
		Replace: every 30,000km or 24 months
Fuel filter	B, C	Replace: every 20,000km or 12 months
Transmission gear oil	A, B, C	Replace: every 30,000km or 24 months

Note: Rigorous road code

- A. Short distance time after time repeat driving
- B. Unpredictable dangerous conditions on road
- C. High Wind Conditions
- D. Cold weather/ bitumen road driving
- E. In cold weather, short distance time after time repeat driving
- F. Often using cold air conditioner (increase quickly)

## 7.4 Simple Inspection and Maintenance Items

### 1) Lubrication system

- Engine oil and oil filter

### 2) Oil quantity check

- Park the vehicle on horizontal ground, check the oil quantity before starting the engine or 2-3 minutes after engine is stopped.

When checking, pull out oil gauge in crankcase, clean it using a cloth. Replace back into oil basin again, pull out it again, oil mark should be located between top and bottom markings (two holes) of the oil gauge, if oil mark is close to bottom line, then oil should be filled to top line.

#### a) Filling oil

Using the engine oil reference;

- Southward all year and northward summer 10W-30SE, northward winter (November to March next year) 5W-30SE.
- Take down the oil cap, filling the specified oil to the limit (3.5L after changing oil filter). Start engine after filling, idle for some time, check oil capacity after engine is turned off for at least 3 minutes.

b) Replace oil and oil filter

- Stop the engine, take down the drain bolt on the engine bottom, drain the oil when the engine body is warm, and fill about 2.8 liters of new oil.
- Start engine and make it run 5 minutes, check oil level after engine has stopped running for at least 3 minutes.

c) Replace oil filter

- Unscrew the oil filter anticlockwise using a special wrench, and then take down it.
- Clean the mounting surface of oil filter using a cleaning cloth.
- Apply a little oil on the rubber washer of the new oil filter.

**WARNING!!!**

**DO NOT UNSCREW DRAIN PLUG WHEN ENGINE IS HOT OR SERIOUS INJURY MAY OCCUR DUE TO HOT OIL.**

- Screw oil filter with hand until the washer comes into contact with mounting surface.
- Screw three-quarter circle more with wrench after contact point.
- Add transmission gear oil.
- The specified transmission gear oil is No.18 synthetic dual curve gear oil.

Remove drain plug before replacing gear oil. Drain out the original oil and add new oil after installing the drain plug. The adding capacity of transmission gear oil is as follows:

Item	Capacity
4 <sup>th</sup> gear	1.0 Liters
5 <sup>th</sup> gear	1.3 Liters

**WARNING!!!**  
**WHEN TIGHTENING OIL FILTER, IT IS IMPORTANT TO IDENTIFY THE CONTACT POSITION EXACTLY BETWEEN THE WASHER AND MOUNTING SURFACE.**

d) Replace oil filter

- Unscrew oil filler plug.
- Unscrew oil drain plug. Drain gear oil in rear-axle housing (put oil in container so as not to pollute the ground.)
- Tighten oil drain plug – tighten torque is 50-70N<sup>o</sup>m.
- Add 1.3L GL-5 80W/90 oil from oil filler hold.
- Tighten oil filler plug – tighten torque is 40-6-N<sup>o</sup>m.

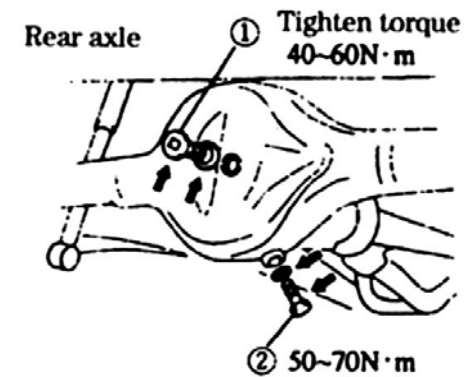

**WARNING!!!**

**AFTER DRIVING, VEHICLE OIL WILL BE HOT AND MAY CAUSE INJURY UPON CONTACT. ENSURE VEHICLE IS COOL BEFORE CHECKING OR REPLACING OIL.**

3) Other liquids

a) Brake fluid

This vehicle uses the 9208 synthetic brake liquid; the level of the fluid in the reservoir should be between the “MIN” mark and “MAX” mark. Fill the same type of braking fluid into the braking system to the “MAX” mark when the fluid level is less than the “MIN” mark.

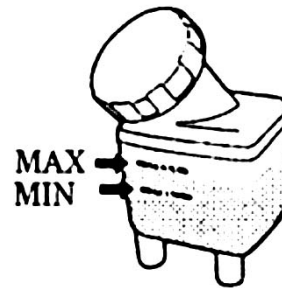

**WARNING!!!**

**WHEN THE BRAKE FLUID LEVEL FALLS TO THE “MIN” MARK, THE BRAKING LIGHT ON THE DASHBOARD WILL TURN ON. SERVICE IMMEDIATELY.**

b) **Engine coolant**

The engine coolant for this vehicle is the FD40 solution. If there is no coolant, DO NOT use hard water due to high acid concentration. Distilled water is recommended. When used in winter, the garage should be heated; otherwise coolant should be drained immediately after shutdown to avoid damaging the radiator and engine.

**WARNING!!!**  
GENERALLY, FREEZING POINT OF THE COOLANT USED SHOULD BE 5°C  
LOWER THAN MINIMUM TEMPERATURE IN OPERATION ZONE.

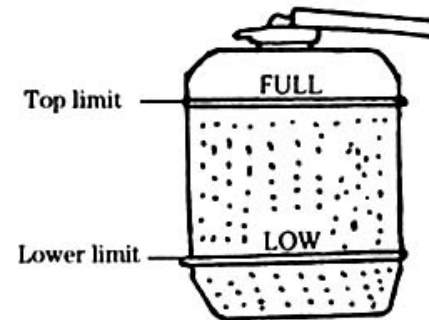

Check the coolant quantity in the tank. It is normal if quantity is between full and low. When it is below “LOW”, the coolant should be filled in using the following steps:

- a) Remove heater relief hose.
- b) Screw out the radiator cover and remove the coolant pot cap.
- c) Fill in the coolant to radiator until it reaches concave position.
- d) Unscrew thermostat relief screw (cannot fall off) drain air.
- e) Tighten thermostat relief screw after draining air, tighten torque  $3.0\text{N}^{\circ}\text{m}$ (31kgf·cm) and add coolant from coolant filler hole.
- f) Repeat item 2-3 three times until coolant leak from bleeder screw.
- g) Add coolant continually into radiator and coolant pot to “FULL” mark.
- h) Insert air relief hose of heater screw radiator cap and pot cap.
- i) Allow engine to run at speed 2000r/min over until the fan begins to run. Stop running engine, add coolant into radiator and coolant pot when the engine is cold.



**WARNING!!!**

**DO NOT OPEN RADIATOR COVER WHEN THE ENGINE IS HOT.**

When replacing coolant for long term usage, you must abide by the following:

- a) Remove radiator cover and open water drain valve on the bottom of radiator to drain the coolant under cooling condition of engine.
- b) Remove the coolant pot nearby the radiator and pour out the coolant.
- c) Drain coolant in jacket of cylinder after removing coolant drain plug of jacket at the bottom of the fourth cylinder
- d) After draining out the coolant in system, install the coolant pot; tighten drain valve, plug and pipe as per original condition. Tighten coolant drain plug at the bottom of radiator and coolant drain plug of jacket at the bottom of the fourth cylinder
- e) Fill in new coolant to the radiator as per filling step and tighten the radiator cover.

**WARNING!!!**

THE VEHICLE MUST BE PARKED ON LEVEL ROAD SURFACE WHEN COOLANT IS REPLACED. WHEN FILLING OR REPLACING THE COOLANT, IT IS SUGGESTED THAT FD40 TYPE VEHICLE ENGINE COOLANT OR GLYCOL AQUEOUS SOLUTION WHICH PH VALUE IS BETWEEN 7.0 AND 8.5 IS ADOPTED. DIFFERENT BRANDS OF COOLANT SHOULD NOT BE MIXED. THE COOLANT SHOULD NOT CONTAIN ALCOHOL OR METHANOL OR COMMON WATER UNDER ANY CIRCUMSTANCES. THIS WILL RESULT IN COOLING SYSTEM DAMAGE.

c) Washer fluid

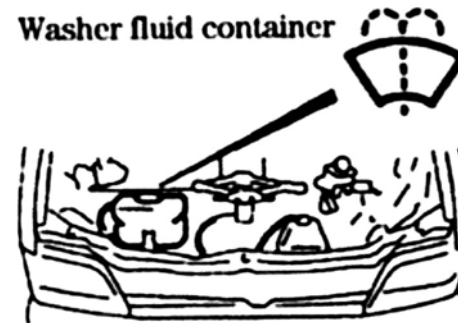

Check the washer regularly to insure the washer fluid is filled to adequate level. The washer fluid level must be between the specified limit marks stamped on the container.

Applied area (season)	Diluting proportion	Frozen Temperature
Normal	1 portion (fluid) and 2 portions(water)	10 Degrees
Cold areas (winter)	1 portion (fluid) and 1 portion (water)	20 Degrees
Extremely cold areas (winter)	Without water	50 Degrees

**WARNING!!!**

**IF THE WASHER FLUID IS EXTREMELY THIN, IT MAY FREEZE ON THE GLASS.  
NEVER START THE WASHER MOTOR WITHOUT WASHER FLUID.**

**4) Air filter**

**WARNING!!!**

**IF AIR FILTER IS JAMMED BY DUST, THE INTAKE RESISTANCE WILL INCREASE.  
THIS WILL RESULT IN DECREASED OUTPUT POWER AND  
INCREASED SPECIFIC FUEL CONSUMPTION.**

5) Tire

Front and rear tire pressure of this vehicle is recorded in pressure label. Always inspect tires for damage, abnormal wear, cracks and impaled objects as well as tire pressure (using pressure gauge) make adjustments if necessary.

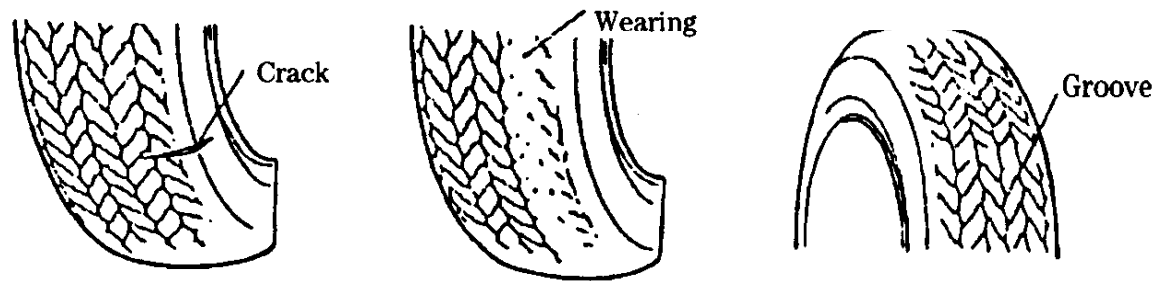

**WARNING!!!**

IT IS RECOMMENDED TO CHECK TIRES IN COLD VS. WARM CONDITIONS FOR ACTUAL RESULTS. WHILE ADDING PRESSURE TO TIRES, STOP WHEN SPECIFIED PRESSURE HAS BEEN REACHED AS THIS MAY RESULT IN OVER-INFLATION WHICH MAY CAUSE TIRE TO EXPLODE. DEPTH OF TIRE GROOVE SHOULD BE OVER 1.6MM. BUMPING THE CURB OR DRIVING OVER STONE CAN DAMAGE TIRE AND CHANGE WHEEL ALIGNMENT.

**WARNING!!!**  
WHEN REPLACING TIRES, USE EXACT SIZE AND DIMENSION WHICH IS IMPERITIVE FOR USE OF THE VEHICLE FOR STEERING WHEEL AND VEHICLE CONTROL CHARACTERISTICS. INSTALLING A DIFFERENT TYPE OF TIRE CAN AFFECT THE READING OF SPEEDOMETER AND ODOMETER.

6) Water pump belt

**WARNING!!!**  
AVOID DIRECT CONTACT THE BELT WHEN THE ENGINE IS RUNNING.

A loose or faulty water pump belt will affect voltage of dynamo and may cause belt to overheat. When checking the tension of belt, apply 100N force to belt in the middle of dynamo and to the water pump. The depressive displacement should be between 7 to 10mm and should be 10 to 15mm for an old belt.

a) Adjusting or changing of water pump belt

- i. Unscrew two bottom screws and two top adjusting screw of AC dynamo when the engine stops running.
- ii. Push dynamo outward until the tension of belt proper and tighten screw. When replacing belt, unscrew screw, push engine inward and take belt down after replacing.

7) Steering wheel

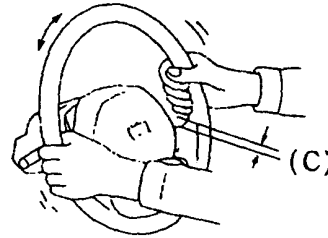

There is natural resistance felt while steering vehicle. To determine natural resistance (which is between 0-30MM), turn the steering wheel left and right slowly. Inspect for smoothness of the operation.

8) Checking clutch pedal

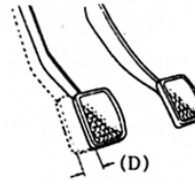

Move clutch pedal with hand and measure the moving gap before you feel light resistance. The gap, which is the clutch pedal free stroke, should be within 20-30MM.

9) Battery

The battery installed in your vehicle only needs simple maintenance. Inspect the battery terminals and the battery bracket for corrosion. To remove the corrosion as necessary, use hard steel brush and ammonia or use the mixture of sodium bicarbonate and water. After removing, rinse with the clear fresh water. When the vehicle is to be left unused for at least 15 days, disconnect the negative (-) terminal of the battery to avoid corrosion.

**WARNING!!!**

**THE FLAMMABLE GASES GENERATED FROM THE BATTERY MIGHT CATCH FIRE AND EXPLODE. KEEP SPARKS AND FLAMES AWAY. DO NOT SMOKE WHEN CHARGING THE BATTERY. WHEN CHECKING THE BATTERY, DISCONNECT NEGATIVE (-) TERMINAL CONNECTED TO THE BATTERY. DO NOT TOUCH THE BATTERY ELECTRODE AND VEHICLE BODY WITH METAL OBJECTS TO AVOID**

## 8) LUBRICATION AND ANTI-CORROSION

### 8.1 Maintenance of Interior

#### 1) Plastic, artificial leather, textile material, fuzzy interiors

Wipe it with soft cloth such as gauze dipped in 3% neutral detergent aqueous solution.

Remove the detergent with a soft cloth soaked in clear fresh water.

#### 2) Carpet material

Use of vacuum cleaner is recommended. Wipe carpet with a soft cloth such as gauze dipped in 3% neutral detergent. Remove the detergent with the soft cloth soaked in clear fresh water.

#### 3) Leather Surfaces

Remove dirt with soft cloth such as gauze, dipped in 3% neutral detergent recommended specifically for leather cleaning.

#### WARNING!!!

THE SURFACE MAYBE DAMAGED IF YOU WIPE IT WITH NYLON OR SYNTHETIC BRUSH. SOLVENT SUCH AS GASOLINE, ACID, ALKALI AND ALCOHOL AND CAN MAKE THE LEATHER FADE. USE A NEUTRAL DETERGENT AQUEOUS SOLUTION. PARKING IN DIRECT SUNLIGHT WILL CAUSE FADING OF LEATHER SURFACE.

## 8.2 Maintenance of Exterior

Foreign matter deposited on paint coat surface such as substance containing salt, chemical preparation, greasy dirt, bird droppings and industrial waste will damage paint coat.

### 1) Cleaning the vehicle body

- a) Water the upper parts of the vehicle.
- b) If water can not remove the dirt, you can use the neutral detergent. Use water to remove the dirt.
- c) Wipe the water with the deerskin or soft cloth.
- d) Do not splash water into engine while cleaning under body as this may result in engine damage.

### **WARNING!!!**

**COIN CAR WASHES HAVE HIGH TEMPERATURE AND PRESSURE. THIS MAY DISTORT AND DEFORM RESIN PARTS. IF USING A CAR WASH, GLASS MUST BE KEPT MORE THAN 50CM AWAY FROM WASH NOZZLE AND AUTO-BODY MUST BE KEPT MORE THAN 40CM AWAY. THE BRAKE SHOULD BE CHECKED FOR DRYING AFTER RINSING OR BEFORE DRIVING.**

**2) Method of waxing**

To protect auto-body further, wax after wash.

- a) It is recommended to wax vehicle only 1 or 2 times per month.
- b) Avoid direct sunlight while waxing vehicle.

**3) Maintenance of windshields and windows**

Always use proper windscreen detergent (glass detergent etc.) to clean windows.

**WARNING!!!**

**AVOID DAMAGE TO THE ELECTRIC FUSE WHILE WASHING INSIDE.**

**4) Maintenance of the wiper**

- a) Clean the rubber with a soft moist/wet cloth.
- b) If the rubber has been worn, replace the brush of the wiper as soon as possible.

**5) Maintenance of the resin parts**

Use sponge to clean surface such as bumper. The bumper color will turn to white when wax has been applied. Remove the wax with soft cloth.

**WARNING!!!**

**DO NOT USE HARD TOOL SUCH AS BRUSH WHILE CLEANING THE SURFACE.  
DO NOT USE WAX WITH ABRASIVE. IF THE VEHICLE HAS BEEN STAINED WITH  
GASOLINE, LIGHT OIL, BRAKE FLUID, OIL, GREASE, SULFURIC OR BATTERY LIQUID,  
USE A SOFT CLOTH WITH NEUTRAL DETERGENT TO CLEAN IT AT ONCE.**

### **8.3 Anti-corrosion of Vehicle**

A vehicle's lifetime can be extended by noting erosion, environmental conditions and maintaining vehicle properly.

#### **1) Causes of Erosion**

- a) Accumulating salt, clay and humidity etc. at uncommon parts in body and chassis.
- b) Scraping the outer protective paint layer because of accident or stone collision.
- c) Environmental conditions accelerate erosion; salty air, industrial pollution, dust full of chemical substance, salt and alkali on roads.
- d) Relative higher humidity, especially in areas where temperature is above zero degree.
- e) Dampness and use of vehicle for extended periods in these areas may lead to rust.
- f) Poor ventilation and drying slowly when in high temperature areas. The vehicle should be parked at a spot where it is dry with good ventilation.